

# Motion Sensors

Many areas like lobbies, parking garages, staircases remain unused for long hours, but do need lighting to be lit automatically in case of movement. A motion sensor is a device, which detects movements, and in some cases light conditions and then transmits a signal for illumination.



## Product Features

- Power saving
- Available for indoor and outdoor purposes
- Compatible with most of our models
- Proven quality from reliable suppliers
- Wide range of models to choose from

## Applications

- Outdoor Areas like parking garages, Gardens compounds and yards
- Indoor areas like walkways, lobbies and staircases.



**Infrared Sensor**

BOX QTY.

**50**

**Max1000W** VT-8027 EAN Code

5086

3800157609173

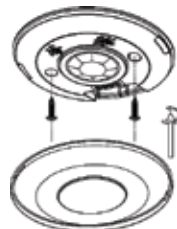

Sensor Type:	<b>Infrared</b>	Time Delay:	<b>*10sec±3sec-15min±2min</b>
Colour:	<b>White</b>	Ambient Light:	<b>*&lt;3-2000LUX</b>
Detection Range:	<b>360°</b>	Body Type:	<b>PC</b>
Voltage:	<b>AC: 220-240V,50/60Hz</b>	Detector:	<b>One</b>
Rated Load:	<b>Max.1000W(LED)</b>	IP Rating:	<b>IP20</b>
Detection Distance:	<b>Max.6m (&lt;24° C)</b>	Dimension:	<b>115x25mm</b>



**Infrared Sensor**

BOX QTY.

**50**

**Max1000W** VT-8027 EAN Code

5087

3800157609180

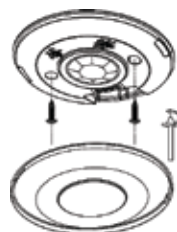

Sensor Type:	<b>Infrared</b>	Time Delay:	<b>*10sec±3sec-15min±2min</b>
Colour:	<b>Black</b>	Ambient Light:	<b>*&lt;3-2000LUX</b>
Detection Range:	<b>360°</b>	Body Type:	<b>PC</b>
Voltage:	<b>AC: 220-240V,50/60Hz</b>	Detector:	<b>One</b>
Rated Load:	<b>Max.1000W(LED)</b>	IP Rating:	<b>IP20</b>
Detection Distance:	<b>Max.6m (&lt;24° C)</b>	Dimension:	<b>115x25mm</b>

*\*Adjustable*

**IP44**  
RATED



**Infrared Sensor**

Max. **400W** VT-8028  
**5088**

**BOX QTY.**

**50**

EAN Code

3800157609197



Sensor Type:	<b>Infrared</b>	Time Delay:	<b>*10sec±3sec-15min±2min</b>
Colour:	<b>White</b>	Ambient Light:	<b>*&lt;3-2000LUX</b>
Detection Range:	<b>180°</b>	Body Type:	<b>PC</b>
Voltage:	<b>AC: 220-240V,50/60Hz</b>	IP Rating:	<b>IP44</b>
Rated Load:	<b>Max.400W(LED)</b>	Dimension:	<b>80x55x70mm</b>
Detection Distance:	<b>Max.12m (&lt;24° C)</b>		

**IP44**  
RATED



**Infrared Sensor**

Max. **400W** VT-8028  
**5089**

**BOX QTY.**

**50**

EAN Code

3800157609203



Sensor Type:	<b>Infrared</b>	Time Delay:	<b>*10sec±3sec-15min±2min</b>
Colour:	<b>Black</b>	Ambient Light:	<b>*&lt;3-2000LUX</b>
Detection Range:	<b>180°</b>	Body Type:	<b>PC</b>
Voltage:	<b>AC: 220-240V,50/60Hz</b>	IP Rating:	<b>IP44</b>
Rated Load:	<b>Max.400W(LED)</b>	Dimension:	<b>80x55x70mm</b>
Detection Distance:	<b>Max.12m (&lt;24° C)</b>		

*\*Adjustable*

**Infrared Sensor**

PIR Sensor Moving Head

BOX QTY.

**50**

Max. **400W** VT-8030

EAN Code

**5091**

3800157609227

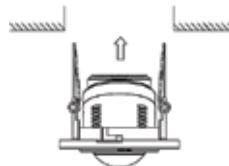

Sensor Type:	<b>Infrared</b>	Time Delay:	<b>*10sec±3sec-15min±2min</b>
Colour:	<b>White</b>	Ambient Light:	<b>*&lt;3-2000LUX</b>
Detection Range:	<b>360°</b>	Body Type:	<b>PC</b>
Voltage:	<b>AC: 220-240V,50/60Hz</b>	IP Rating:	<b>IP20</b>
Rated Load:	<b>Max.400W(LED)</b>	Dimension:	<b>80 x 63 x 71mm</b>
Detection Distance:	<b>Max.8m (&lt;24° C)</b>		

**Infrared Sensor**

Max. **300W** VT-8029

BOX QTY.

**50**

EAN Code

**5090**

3800157609210

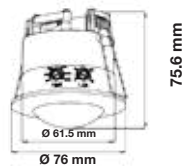

Sensor Type:	<b>Infrared</b>	Time Delay:	<b>*10sec±3sec-15min±2min</b>
Colour:	<b>White</b>	Ambient Light:	<b>*&lt;3-2000LUX</b>
Detection Range:	<b>360°</b>	Body Type:	<b>PC</b>
Voltage:	<b>AC: 220-240V,50/60Hz</b>	IP Rating:	<b>IP20</b>
Rated Load:	<b>Max.300W(LED)</b>	Dimension:	<b>76 x 75.6mm</b>
Detection Distance:	<b>Max.6m (&lt;24° C)</b>		

**IP44**  
RATED



**Infrared Sensor**

Max. **300W** VT-8003  
**4967**

BOX QTY.

**50**

EAN Code  
3800230625823



Sensor Type:	<b>Infrared</b>	Time Delay:	<b>*10sec±3sec-7min±2min</b>
Colour:	<b>White</b>	Ambient Light:	<b>*&lt;3-2000LUX</b>
Detection Range:	<b>180°</b>	Body Type:	<b>PC</b>
Voltage:	<b>AC: 220-240V,50/60 Hz</b>	Detector:	<b>One</b>
Rated Load:	<b>Max.300W(LED)</b>	IP Rating:	<b>IP44</b>
Detection Distance:	<b>Max.12m (&lt;24° C)</b>	Dimension:	<b>86.4 x 60.4 x 98mm</b>

**IP44**  
RATED



**Infrared Sensor**

Max. **300W** VT-8003  
**5077**

BOX QTY.

**50**

EAN Code  
3800157606875



Sensor Type:	<b>Infrared</b>	Time Delay:	<b>*10sec±3sec-7min±2min</b>
Colour:	<b>Black</b>	Ambient Light:	<b>*&lt;3-2000LUX</b>
Detection Range:	<b>180°</b>	Body Type:	<b>PC</b>
Voltage:	<b>AC: 220-240V,50/60 Hz</b>	Detector:	<b>One</b>
Rated Load:	<b>Max.300W(LED)</b>	IP Rating:	<b>IP44</b>
Detection Distance:	<b>Max.12m (&lt;24° C)</b>	Dimension:	<b>86.4 x 60.4 x 98mm</b>

*\*Adjustable*



**Infrared Sensor**

Max. **60W** VT-8005  
**4982**

**BOX QTY.**

**50**

EAN Code  
 3800157600071

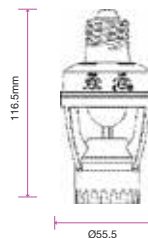

Sensor Type:	<b>Infrared</b>	Time Delay:	<b>*10sec±3sec-5min±1min</b>
Colour:	<b>White</b>	Ambient Light:	<b>*&lt;3-2000LUX</b>
Detection Range:	<b>360°</b>	Body Type:	<b>PC</b>
Voltage:	<b>AC: 110-240V, 50/60Hz</b>	IP Rating:	<b>IP20</b>
Rated Load:	<b>Max.60W(E27)</b>	Dimension:	<b>Ø55.5 x 116.5mm</b>
Detection Distance:	<b>Max.6m (&lt;24° C)</b>		

**Infrared Sensor**

Max. **300W** VT-8004  
**4968**

**BOX QTY.**

**50**

EAN Code  
 3800230625830

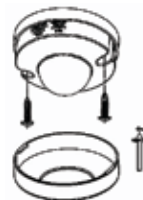

Sensor Type:	<b>Infrared</b>	Time Delay:	<b>*10sec±3sec-15min±2min</b>
Colour:	<b>White</b>	Ambient Light:	<b>*&lt;3-2000LUX</b>
Detection Range:	<b>360°</b>	Body Type:	<b>PC</b>
Voltage:	<b>AC: 220-240V,50/60Hz</b>	Detector:	<b>Three</b>
Rated Load:	<b>Max.300W(LED)</b>	IP Rating:	<b>IP20</b>
Detection Distance:	<b>Max.12m (&lt;24° C)</b>	Dimension:	<b>88 x 55mm</b>

*\*Adjustable*

NEW



**Infrared Sensor**

**Max1200W** VT-8048 EAN Code

1354

BOX QTY.

**50**

3800157624794



Sensor Type:	<b>Infrared</b>	Time Delay:	<b>*Min.10sec±3sec-</b>
Colour:	<b>White</b>		<b>Max 7min±2min</b>
Detection Range:	<b>180°</b>	Ambient Light:	<b>*&lt;3-2000LUX</b>
Voltage:	<b>AC:220-240V,50/60Hz</b>	Body Type:	<b>PC</b>
Rated Load:	<b>Max 1200w</b>	IP Rating:	<b>IP44</b>
Detection Distance:	<b>12m (&lt;24° C)</b>	Dimension:	<b>86.4 x 60.4 x 98mm</b>

**MANUAL OVERRIDE FUNCTION:**

1. Automatic Sensor Override Mode - Turn the switch OFF and ON within 3 Seconds, the sensor will be overridden and switched off. The light will work continuously and normally.(Make sure the automatic mode is switched ON before using this functionality)
2. Sensor Switch On - Turn the switch OFF for 20 seconds and switch it back ON. The sensor will restart and work as per the settings adjusted.
3. If the light is left idle for a longer period of time, the sensor will automatically switch back to automatic mode(Possible when the outside light reaches 100Lux)

NEW



**Infrared Sensor**

**Max1200W** VT-8049 EAN Code

1355

BOX QTY.

**50**

3800157624800

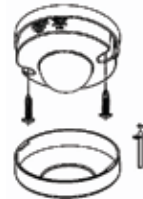

Sensor Type:	<b>Infrared</b>	Time Delay:	<b>*Min.10sec±3sec-</b>
Colour:	<b>White</b>		<b>Max 15min±2min</b>
Detection Range:	<b>360°</b>	Ambient Light:	<b>*&lt;3-2000LUX</b>
Voltage:	<b>AC:220-240V,50/60Hz</b>	Body Type:	<b>PC</b>
Rated Load:	<b>Max 1200w</b>	IP Rating:	<b>IP20</b>
Detection Distance:	<b>12m</b>	Dimension:	<b>Ø 88 x 55mm</b>

**MANUAL OVERRIDE FUNCTION:**

1. Automatic Sensor Override Mode - Turn the switch OFF and ON within 3 Seconds, the sensor will be overridden and switched off. The light will work continuously and normally.(Make sure the automatic mode is switched ON before using this functionality)
2. Sensor Switch On - Turn the switch OFF for 20 seconds and switch it back ON. The sensor will restart and work as per the settings adjusted.
3. If the light is left idle for a longer period of time, the sensor will automatically switch back to automatic mode(Possible when the outside light reaches 100Lux)

NEW



**Infrared Sensor**

**Max300W** VT-8051

1356

BOX QTY.

50

EAN Code

3800157624817

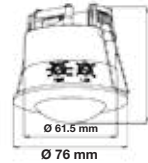

75.6 mm

Sensor Type:	<b>Infrared</b>	Time Delay:	<b>*Min.10sec±3sec-</b>
Colour:	<b>White</b>		<b>Max 15min±2min</b>
Detection Range:	<b>Max 6m(&lt;24° C)</b>	Ambient Light:	<b>*&lt;3-2000LUX</b>
Voltage:	<b>AC:220-240V,50/60Hz</b>	Body Type:	<b>PC</b>
Rated Load:	<b>Max 300w(LED)</b>	IP Rating:	<b>IP20</b>
Detection Distance:	<b>12m</b>	Dimension:	<b>Ø 76 x 75.6mm</b>

**MANUAL OVERRIDE FUNCTION:**

1. Automatic Sensor Override Mode - Turn the switch OFF and ON within 3 Seconds, the sensor will be overridden and switched off. The light will work continuously and normally.(Make sure the automatic mode is switched ON before using this functionality)
2. Sensor Switch On - Turn the switch OFF for 20 seconds and switch it back ON. The sensor will restart and work as per the settings adjusted.
3. If the light is left idle for a longer period of time, the sensor will automatically switch back to automatic mode(Possible when the outside light reaches 100Lux)

NEW



**Daylight Sensor**

VT-8059

1369

EAN Code

3800157625982

BOX QTY.

100

Colour:	<b>white</b>
Detection Range:	<b>360°</b>
Dimming Range:	<b>1% - 100%</b>
Voltage:	<b>1-10V DC</b>
Body Type:	<b>plastic</b>
IP Rating:	<b>IP20</b>

Daylight sensor supplies a simple and effective solution for daylight harvesting. Connecting to 1-10V Power source and using with LED dimmable driver. The illuminations level of lamps will get darker when ambient light gets brighter. When daylight is insufficient, the lamp will be in 100% Illumination level, and turns to 1% Level when daylight is sufficient enough, then gradually back to 100% level when it is getting darker.

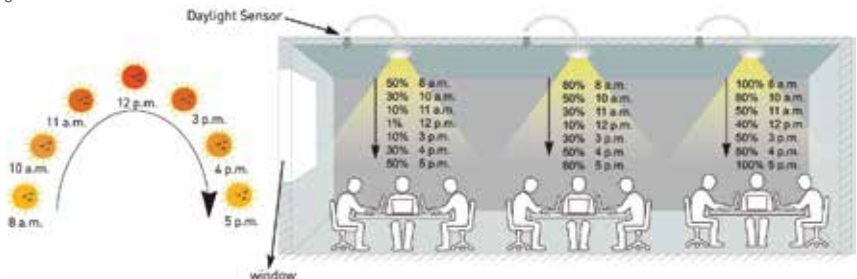





On/Off via moving hand

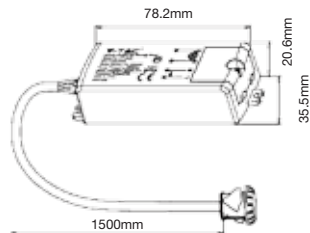

## Motion Sensor

Max. **200W** VT-8025  
5084

EAN Code  
3800157608046

BOX QTY.  
**100**

Sensor Type:	<b>Infrared</b>	Detection Distance:	<b>5-6cm (&lt;24°C)</b>
Colour:	<b>White</b>	Body Type:	<b>Plastic</b>
Detection Range:	<b>30°</b>	Detector:	<b>One</b>
Voltage:	<b>AC: 110-240V, 50/60Hz</b>	IP Rating:	<b>IP20</b>
Rated Load:	<b>Max.200W(LED)</b>	Dimension:	<b>35.5 x 78.2 x 20.6mm</b>



On/Off via the opening and closing of the door

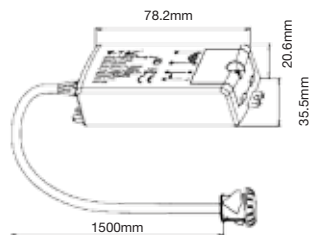

## Motion Sensor

Max. **200W** VT-8026  
5085

EAN Code  
3800157608053

BOX QTY.  
**100**

Sensor Type:	<b>Infrared</b>	Detection Distance:	<b>5-6cm (&lt;24°C)</b>
Colour:	<b>White</b>	Body Type:	<b>Plastic</b>
Detection Range:	<b>30°</b>	Detector:	<b>One</b>
Voltage:	<b>AC: 110-240V, 50/60Hz</b>	IP Rating:	<b>IP20</b>
Rated Load:	<b>Max.200W(LED)</b>	Dimension:	<b>35.5 x 78.2 x 18.7mm</b>



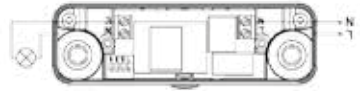

**Microwave Sensor**

Max. **200W** VT-8036  
5571

EAN Code  
3800157620246

BOX QTY.  
**100**

Sensor Type:	<b>Microwave</b>	Time Delay:	<b>*5sec±90sec-3min±20min</b>
Colour:	<b>White</b>	Ambient Light:	<b>*&lt;25-2000LUX</b>
Detection Range:	<b>180°</b>	Body Type:	<b>PC</b>
Voltage:	<b>AC: 220-240V,50/60Hz</b>	IP Rating:	<b>IP65</b>
Rated Load:	<b>Max.200W</b>	Dimension:	<b>115 x 35 x25mm</b>
Detection Distance:	<b>5m /10m</b>		

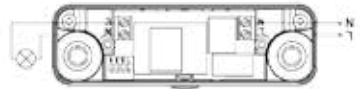

**Microwave Sensor**

Max. **200W** VT-8036  
5572

EAN Code  
3800157620253

BOX QTY.  
**100**

Sensor Type:	<b>Microwave</b>	Time Delay:	<b>*5sec±90sec-3min±20min</b>
Colour:	<b>Black</b>	Ambient Light:	<b>*&lt;25-2000LUX</b>
Detection Range:	<b>180°</b>	Body Type:	<b>PC</b>
Voltage:	<b>AC: 220-240V,50/60Hz</b>	IP Rating:	<b>IP65</b>
Rated Load:	<b>Max.200W</b>	Dimension:	<b>115 x 35 x25mm</b>
Detection Distance:	<b>5m /10m</b>		

*\*Adjustable*



**Housing for Microwave Sensor**

VT-8021 EAN Code  
**5079** 3800157606899

**BOX QTY.**  
**50**

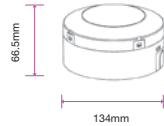

Sensor Type:	<b>Microwave</b>
Colour:	<b>White</b>
IP Rating:	<b>IP65</b>
Dimension:	<b>Ø134 x 66.5mm</b>

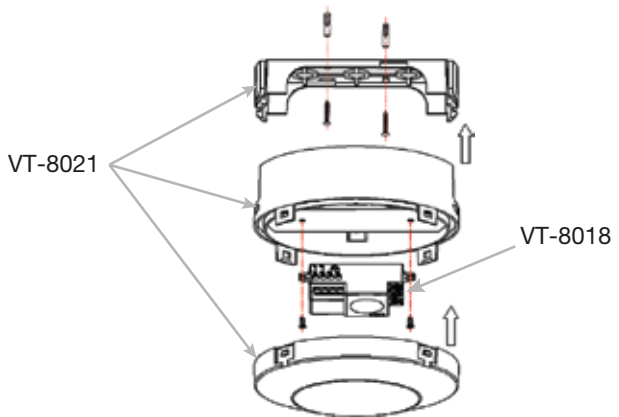

**Microwave Sensor**

Max. **300W** VT-8018  
**5078**

**BOX QTY.**  
**100**

EAN Code  
 3800157606882

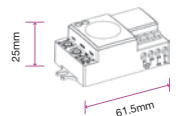

Sensor Type:	<b>Microwave</b>	Time Delay:	<b>*10sec±3sec-12min±1min</b>
Colour:	<b>White</b>	Ambient Light:	<b>*&lt;3-2000LUX</b>
Detection Range:	<b>180/360°</b>	Body Type:	<b>Plastic</b>
Voltage:	<b>AC: 220-240V,50/60Hz</b>	Detector:	<b>One</b>
Rated Load:	<b>Max.300W (LED)</b>	IP Rating:	<b>IP20</b>
Detection Distance:	<b>*1-8m (radius)</b>	Dimension:	<b>61.5 x 37x 25 mm</b>

*\*Adjustable*

**IP44**  
RATED



## Photocell Sensor

VT-8019  
5081

BOX QTY.  
**100**

EAN Code  
3800157608015



Sensor Type:	<b>Photocell</b>	Ambient Light:	<b>*&lt;5-15LUX</b>
Colour:	<b>White</b>	Body Type:	<b>Plastic</b>
Detection Range:	<b>360°</b>	Detector:	<b>One</b>
Voltage:	<b>AC: 220-240V, 50/60Hz</b>	IP Rating:	<b>IP44</b>
Rated Current:	<b>6A</b>	Dimension:	<b>35.5 x 46 x 44.1mm</b>

**IP44**  
RATED



## Infrared Sensor

Max. **800W** VT-8022  
5082

BOX QTY.  
**100**

EAN Code  
3800157608022

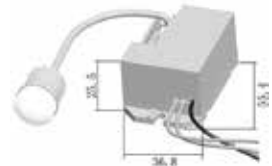

Sensor Type:	<b>Infrared</b>	Time Delay:	<b>*5 sec to 8 min</b>
Colour:	<b>White</b>	Ambient Light:	<b>*10 Lux/2000 Lux</b>
Detection Range:	<b>120/360°</b>	Body Type:	<b>PC</b>
Voltage:	<b>AC: 220-240V, 50Hz</b>	Detector:	<b>Three</b>
Rated Load:	<b>Max.500/800W</b>	IP Rating:	<b>IP44</b>
Detection Distance:	<b>3m/6m(choice) (&lt;24°C)</b>	Dimension:	<b>36.8 x 25.5 x 55.4mm</b>

## Microwave Sensor

Max. **1200W** VT-8023  
5083

BOX QTY.  
**100**

EAN Code  
3800157608039

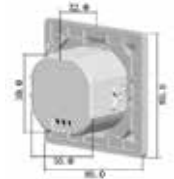

Sensor Type:	<b>Microwave</b>	Time Delay:	<b>*10Sec+3Sec to 12min+1min</b>
Colour:	<b>White</b>	Ambient Light:	<b>*&lt;3-2000LUX</b>
Detection Range:	<b>180°</b>	Body Type:	<b>Plastic</b>
Voltage:	<b>AC: 220-240V, 50/60Hz</b>	Detector:	<b>One</b>
Rated Load:	<b>Max.1200W</b>	IP Rating:	<b>IP20</b>
Detection Distance:	<b>*5m - 15m</b>	Dimension:	<b>80 x 80 x 32mm</b>

*\*Adjustable*